

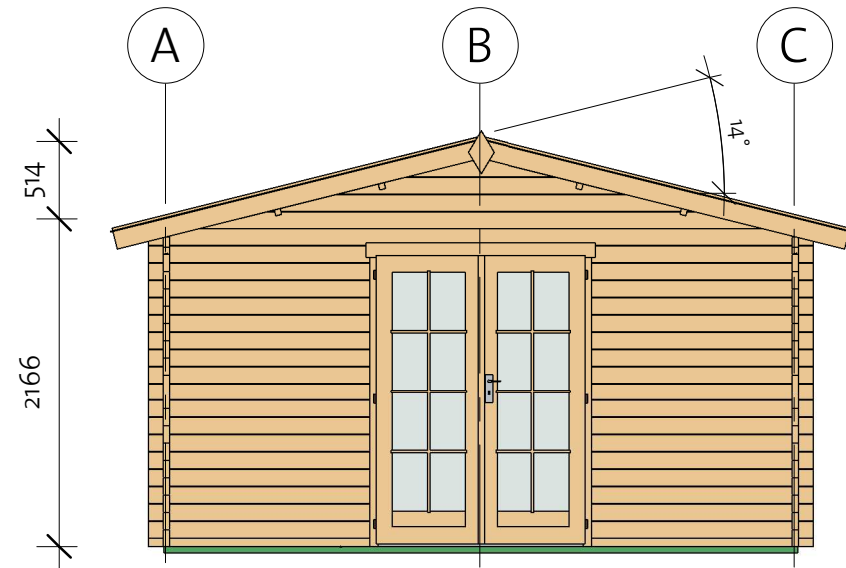

Vello 1 40 (420x480)

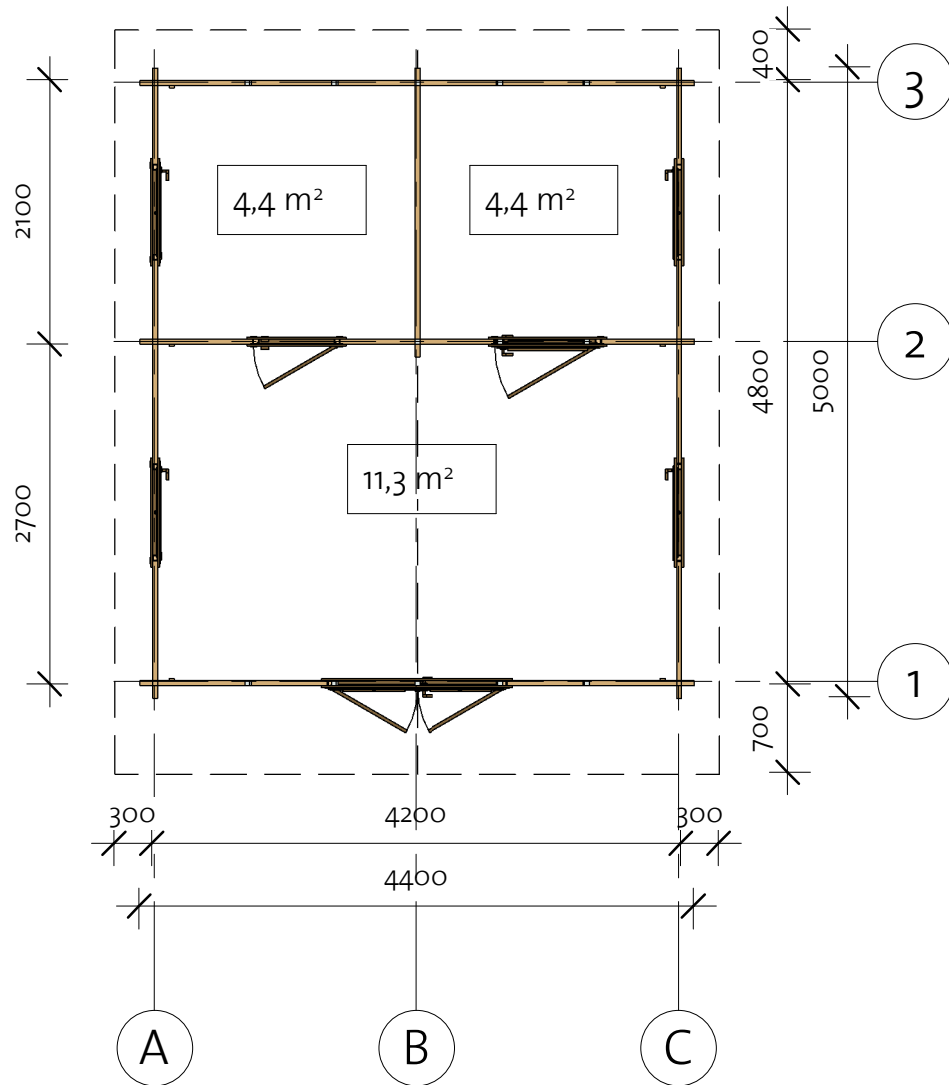
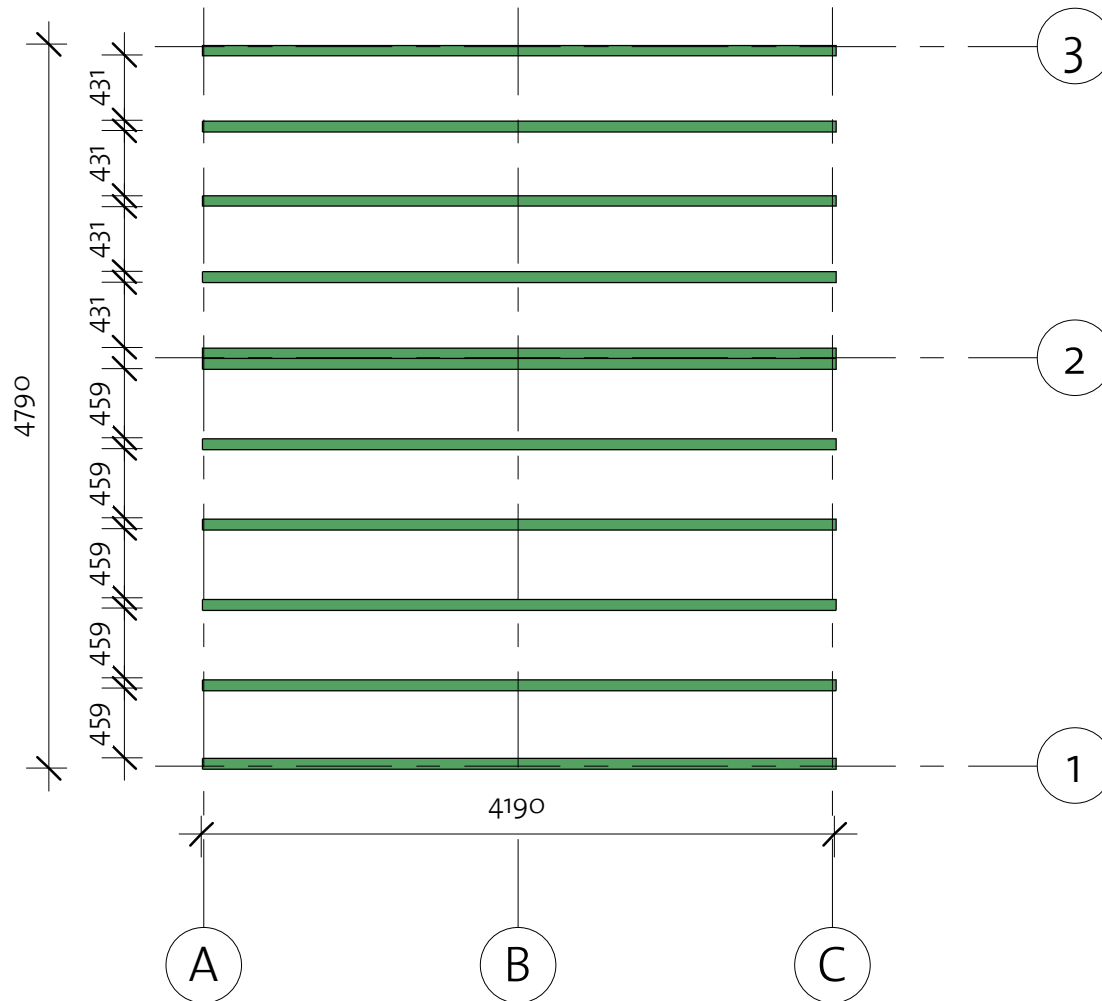

Vello 1 40 (420x480)

Foundation



Impregnated foundation beams				
Mark	Type	Profile	Count	Length
IFB	IFB 70x40		11	4190



Vello 1 40 (420x480)

Floor Plan

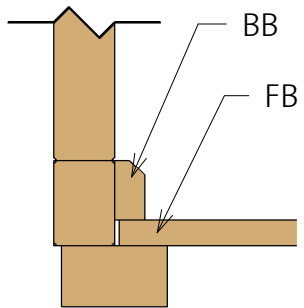
① Baseboard



Floor Schedule

Mark	Type	Profile	Count	Length
FB1	FB 17x114		37	2654
FB2	FB 17x114		38	2014
BB1	BB 20x40		2	4800
BB2	BB 20x40		2	3800

240830

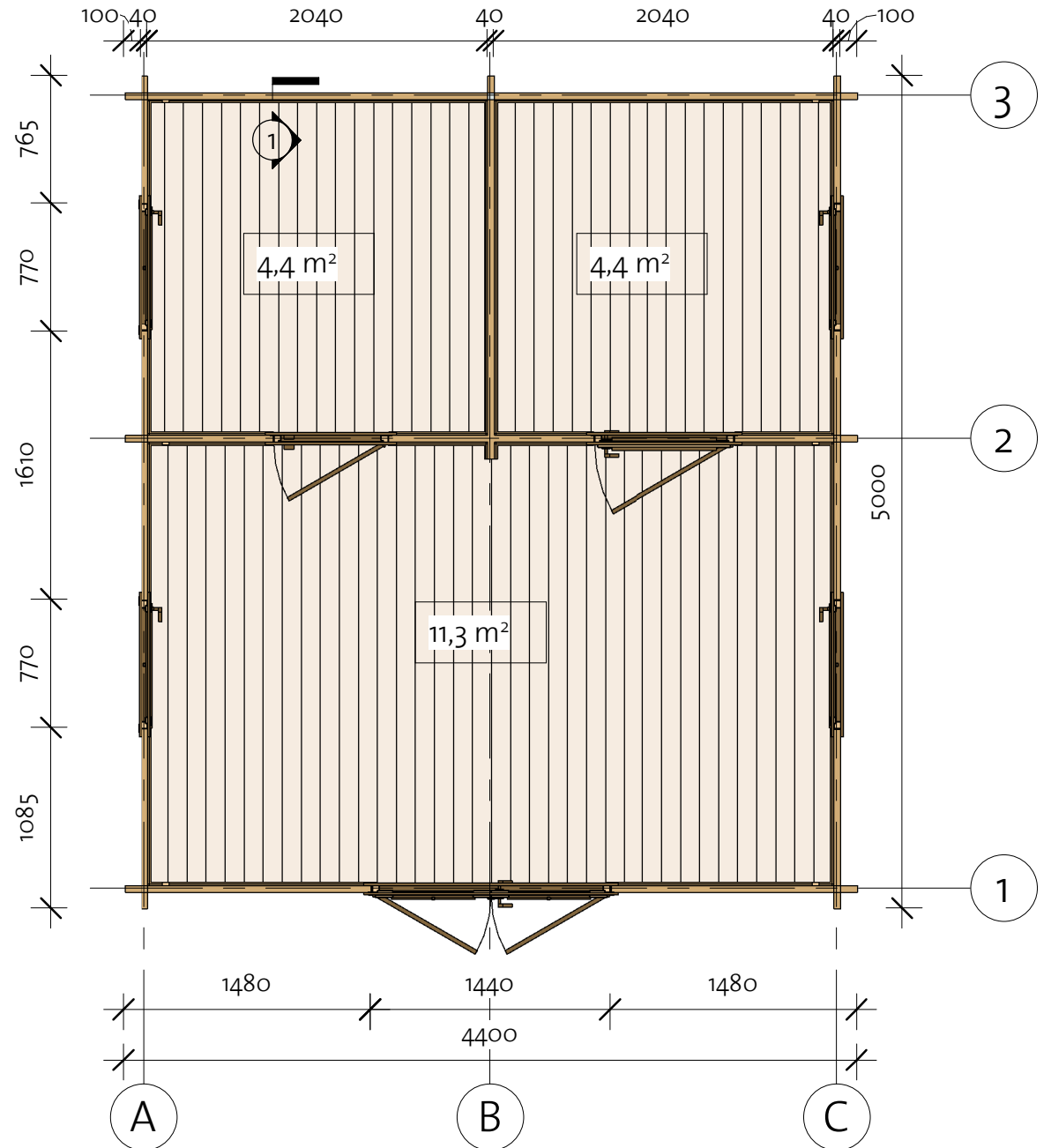

Vello 1 40 (420x480)

Wall 1

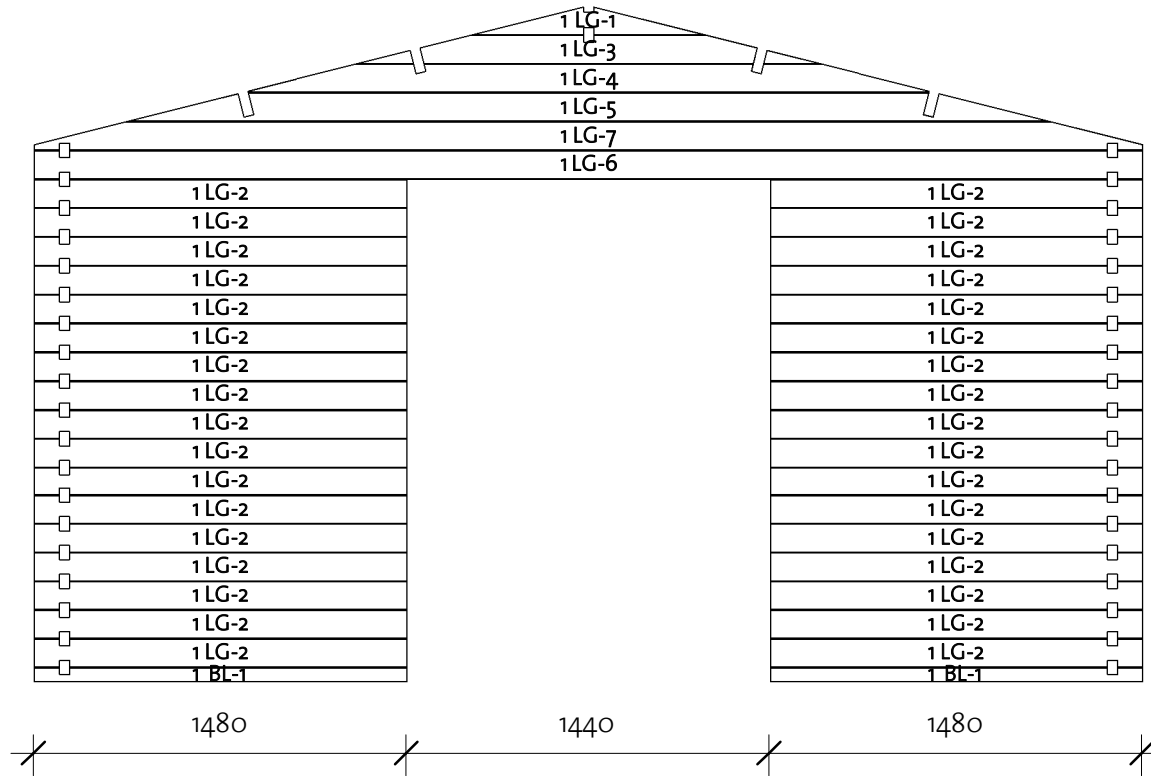
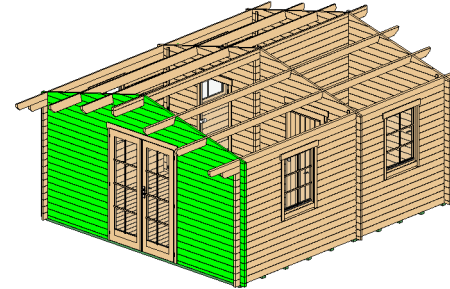

Wall 1			
Mark	Profile	Count	Cut Length

1BL-1	40x57	2	1480
1LG-1*	40x114	1	922
1LG-2	40x114	34	1480
1LG-3*	40x114	1	1836
1LG-4*	40x114	1	2707
1LG-5*	40x114	1	3663
1LG-6	40x114	1	4400
1LG-7*	40x114	1	4400

*Gable-delivered premounted

Log Profile Wall 1	
Profile	Profile

40x57	
40x114	

Vello 1 40 (420x480)

Wall 2

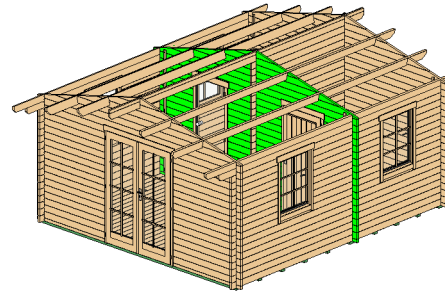

*Gable-delivered premounted

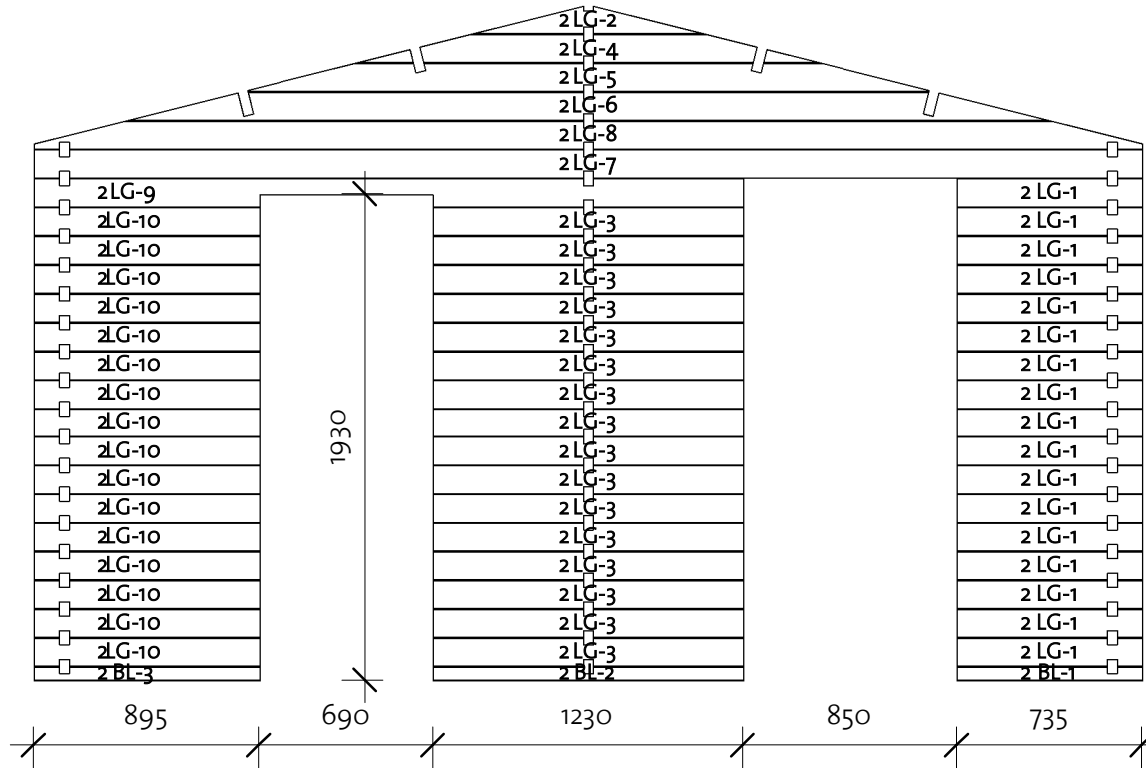

Wall 2

Mark	Profile	Count	Cut Length
2BL-1	40x57	1	735
2BL-2	40x57	1	1230
2BL-3	40x57	1	895
2LG-1	40x114	17	735
2LG-2*	40x114	1	922
2LG-3	40x114	16	1230
2LG-4*	40x114	1	1836
2LG-5*	40x114	1	2707
2LG-6*	40x114	1	3663
2LG-7	40x114	1	4400
2LG-8*	40x114	1	4400
2LG-9	40x114	1	2815
2LG-10	40x114	16	895

Log Profile Wall 2

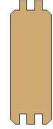
Profile	Profile
40x57	
40x114	

Vello 1 40 (420x480)

Wall 3

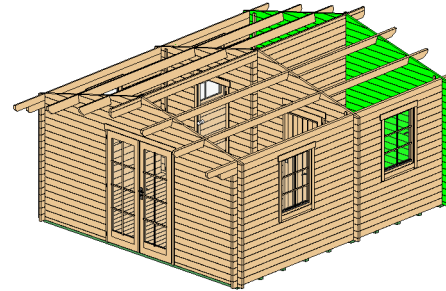

Wall 3			
Mark	Profile	Count	Cut Length

3BL-1	40x57	1	4400
3LG-1*	40x114	1	922
3LG-2*	40x114	1	1836
3LG-3*	40x114	1	2707
3LG-4*	40x114	1	3663
3LG-5	40x114	18	4400
3LG-6*	40x114	1	4400

*Gable-delivered premounted

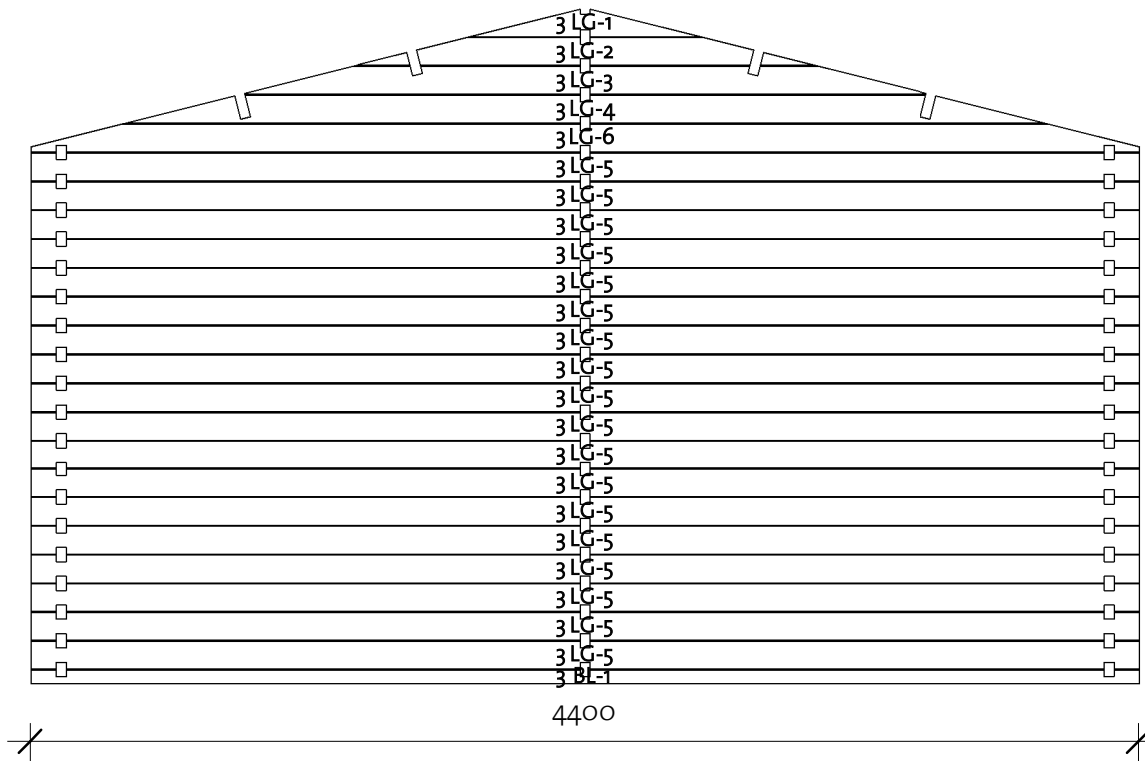

Log Profile Wall 3	
Profile	Profile

40x57	
40x114	

Vello 1 40 (420x480)

Wall A

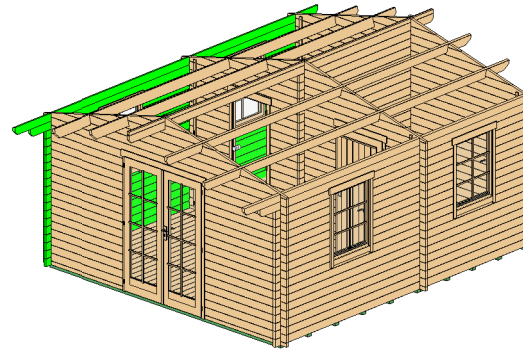

Wall A			
Mark	Profile	Count	Cut Length

ALG-1	40x114	9	763
ALG-2	40x114	9	1083
ALG-3	40x114	9	1605
ALG-4	40x114	8	5000
ALG-5	40x114	1	5300
ATL-1	40x114	1	5900

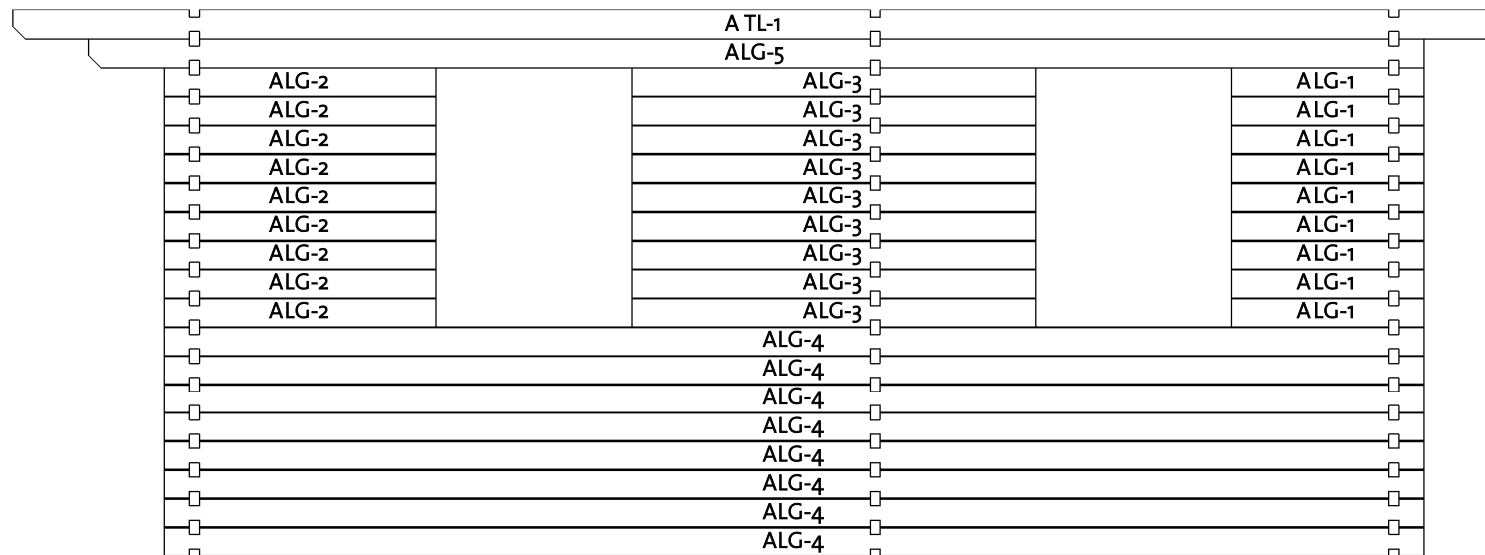

Log Profile Wall A	
Profile	Profile

40x114	
40x114	

Vello 1 40 (420x480)

Wall B

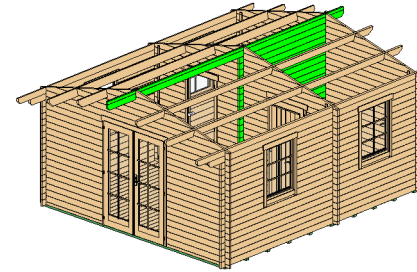

Wall B			
Mark	Profile	Count	Cut Length

BLG-1	40X114	22	2300
BLG-2	40X114	1	5900
BTL-1	40X58	1	5900

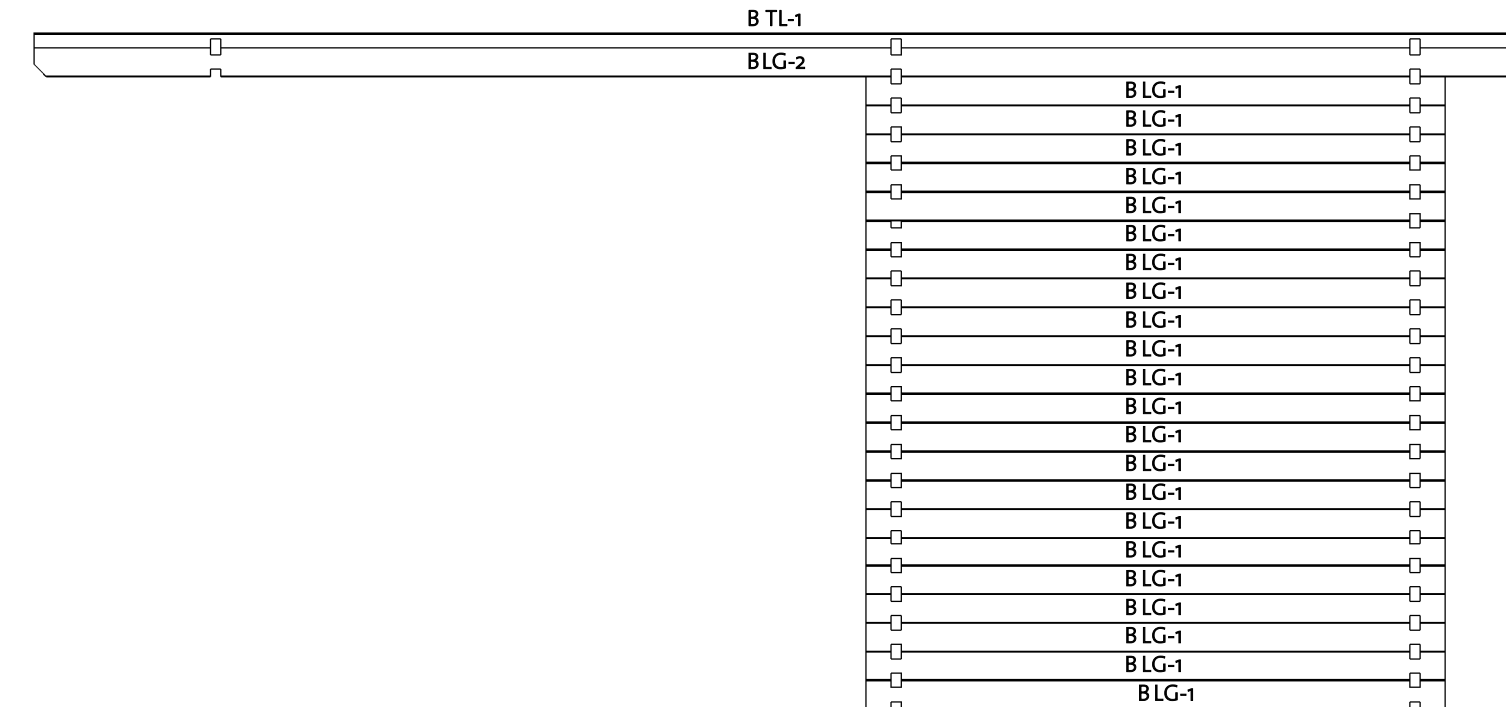

Log Profile Wall B	
Profile	Profile

40X114	
40X58	

Vello 1 40 (420x480)

Wall C

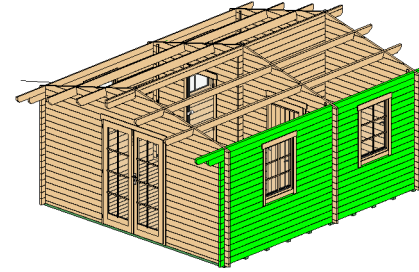

Wall C			
Mark	Profile	Count	Cut Length

CLG-1	40x114	9	763
CLG-2	40x114	9	1083
CLG-3	40x114	9	1605
CLG-4	40x114	8	5000
CLG-5	40x114	1	5300
CTL-1	40x114	1	5900

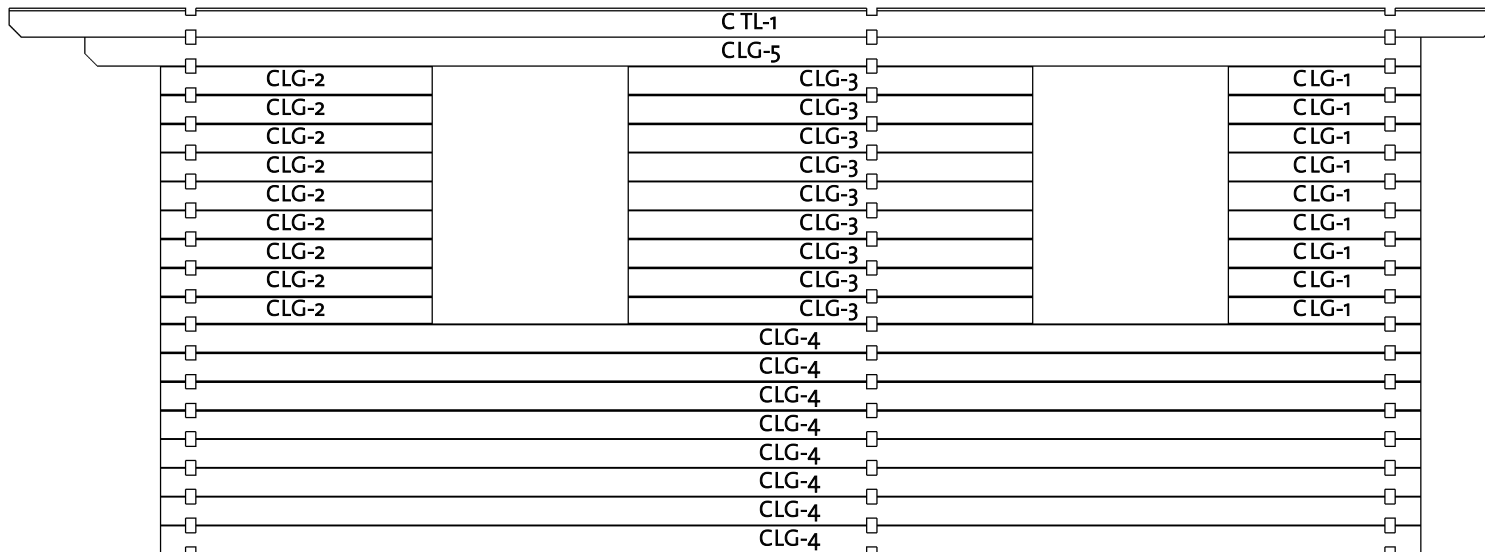

Log Profile Wall C	
Profile	Profile



40x114	
40x114	

Vello 1 40 (420x480)

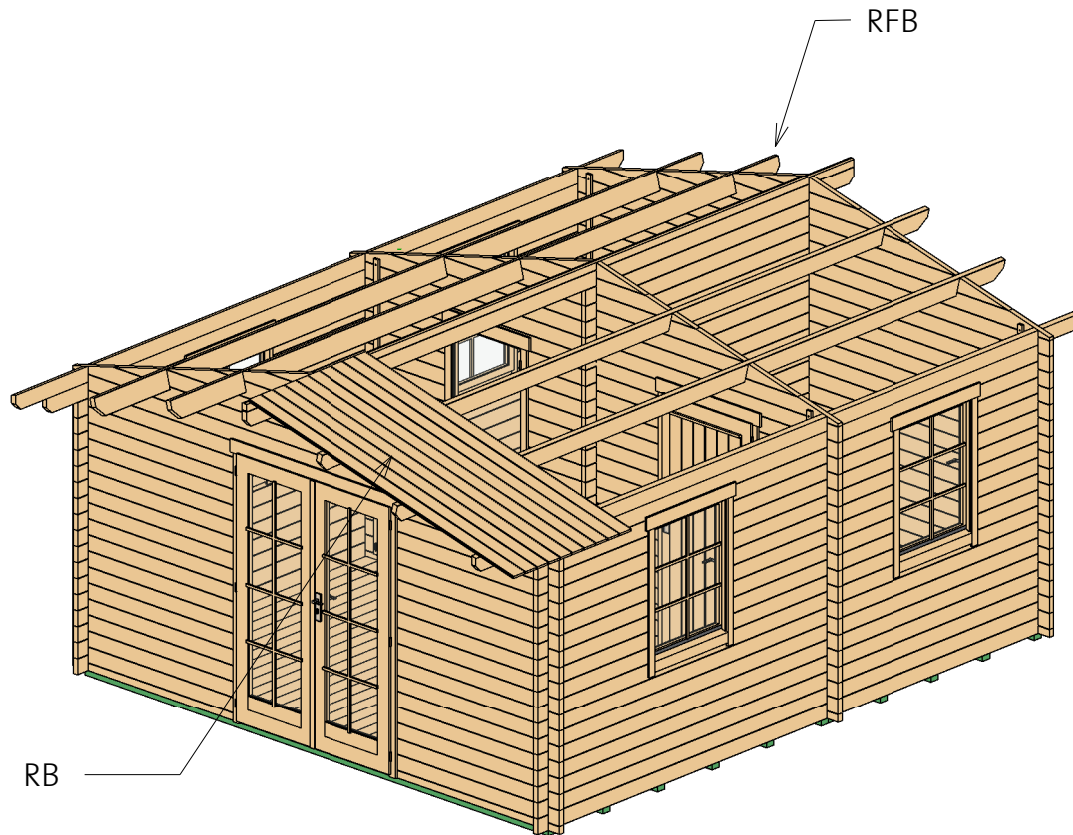
Roof 1



Roof				
Mark	Type	Profile	Count	Length

RFB	Beam 40x143		4	5900
RB	17x114		106	2469

Vello 1 40 (420x480)

Roof 2

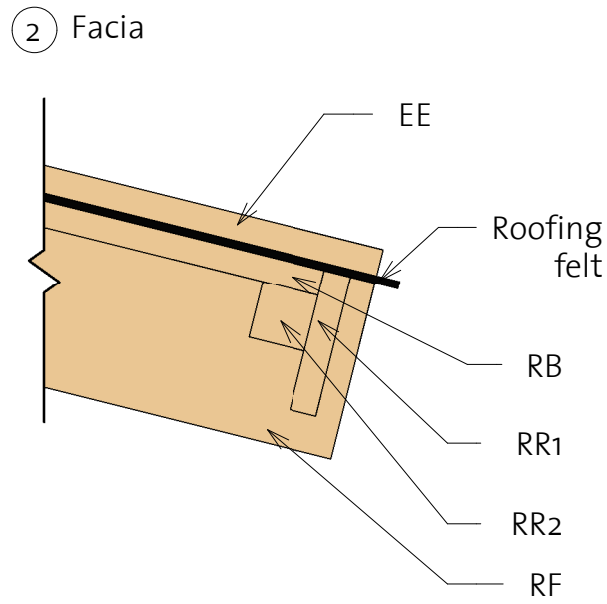
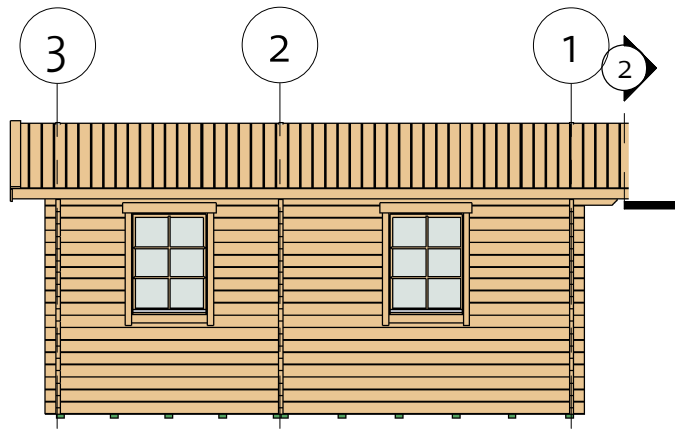

Fascia Schedule				
Mark	Type	Profile	Count	Length
EE	Eave Edging 18x95		4	2508
RF	Roof Fascia 18x120		4	2508
RR1	Roof reinforcement 18x95		2	5900
RR2	Roof reinforcement 38x38		2	5900

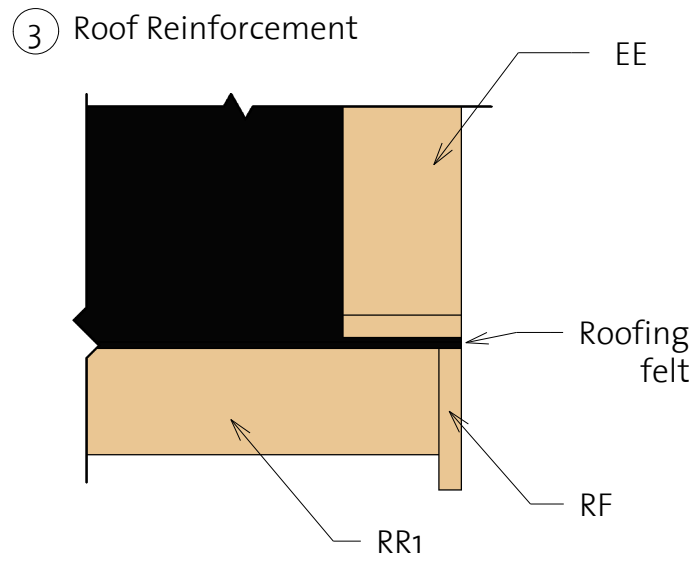
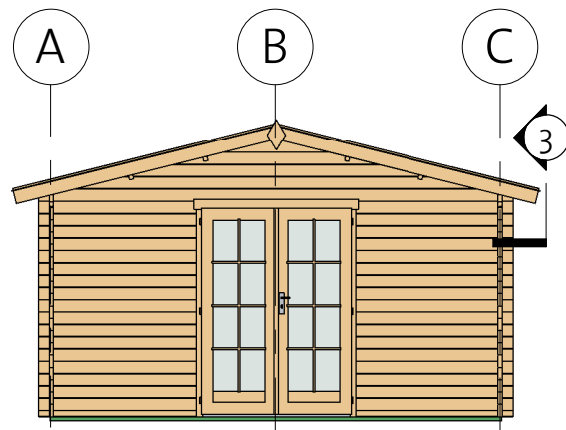

Vello 1 40 (420x480)

Extras

CD7R	Classic door 7, wood right	840	1955	1
CDD3R	Classic double door 3 right	1425	1955	1
SD	Sauna door	685	1920	1

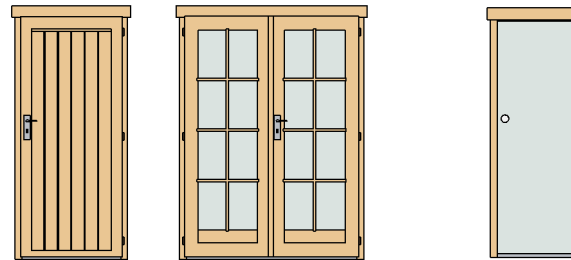





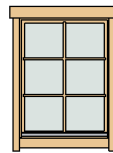

DCB8	Door Crossbar 8			1
------	--------------------	--	--	---

CW1L	Classic window 1 left	765	990	2
CW1R	Classic window 1 right	765	990	2



WCB6	Windows Crossbar 6	--	--	4
------	-----------------------	----	----	---

Hitblock	300-400 mm		
Bolts	M8 x 70		18
Screws	5,0 x 70		30
Screws	6,0 x 140		40
Nails	1,4 x 40		40
Screws	4,0 x 40		840

Romb	2
------	---

Windboard		
Type	Count	Length

Windboard 18x40	6	2200
-----------------	---	------

240830

Vello 1 40 (420x480)

List of all items 1

Impregnated foundation beams

Mark	Type	Profile	Count	Length
------	------	---------	-------	--------

IFB	IFB 70x40		11	4190
-----	--------------	---	----	------

BB1	BB 20x40		2	4800
-----	-------------	---	---	------

BB2	BB 20x40		2	3800
-----	-------------	--	---	------

Floor Schedule

Mark	Type	Profile	Count	Length
------	------	---------	-------	--------

FB1	FB 17x114		37	2654
-----	-----------	---	----	------

FB2	FB 17x114		38	2014
-----	-----------	--	----	------

Roof

Mark	Type	Profile	Count	Length
------	------	---------	-------	--------

RFB	Beam 40x143		4	5900
-----	----------------	---	---	------

RB	17x114		106	2469
----	--------	---	-----	------

Fascia Schedule

Mark	Type	Profile	Count	Length
------	------	---------	-------	--------

EE	Eave Edging 18x95		4	2508
----	-------------------------	---	---	------

RF	Roof Fascia 18x120		4	2508
----	--------------------------	---	---	------

RR1	Roof reinforce ment 18x95		2	5900
-----	------------------------------------	---	---	------

RR2	Roof reinforce ment 38x38		2	5900
-----	------------------------------------	---	---	------

Vello 1 40 (420x480)

List of all items 2

Wall 1			
Mark	Profile	Count	Cut Length

1BL-1	40X57	2	1480
1LG-1 *	40X114	1	922
1LG-2	40X114	34	1480
1LG-3 *	40X114	1	1836
1LG-4 *	40X114	1	2707
1LG-5 *	40X114	1	3663
1LG-6	40X114	1	4400
1LG-7 *	40X114	1	4400

*Gable-delivered premounted

Wall 3			
Mark	Profile	Count	Cut Length

3BL-1	40X57	1	4400
3LG-1 *	40X114	1	922
3LG-2 *	40X114	1	1836
3LG-3 *	40X114	1	2707
3LG-4 *	40X114	1	3663
3LG-5	40X114	18	4400
3LG-6 *	40X114	1	4400

Wall A			
Mark	Profile	Count	Cut Length

ALG-1	40X114	9	763
ALG-2	40X114	9	1083
ALG-3	40X114	9	1605
ALG-4	40X114	8	5000
ALG-5	40X114	1	5300
ATL-1	40X114	1	5900

Wall 2			
Mark	Profile	Count	Cut Length

2BL-1	40X57	1	735
2BL-2	40X57	1	1230
2BL-3	40X57	1	895
2LG-1	40X114	17	735
2LG-2 *	40X114	1	922
2LG-3	40X114	16	1230
2LG-4 *	40X114	1	1836
2LG-5 *	40X114	1	2707
2LG-6 *	40X114	1	3663
2LG-7	40X114	1	4400
2LG-8 *	40X114	1	4400
2LG-9	40X114	1	2815
2LG-10	40X114	16	895

Wall B			
Mark	Profile	Count	Cut Length

BLG-1	40X114	22	2300
BLG-2	40X114	1	5900
BTL-1	40X58	1	5900



Wall C			
Mark	Profile	Count	Cut Length

CLG-1	40X114	9	763
CLG-2	40X114	9	1083
CLG-3	40X114	9	1605
CLG-4	40X114	8	5000
CLG-5	40X114	1	5300
CTL-1	40X114	1	5900

Vello 1 40 (420x480)

List of all items 3

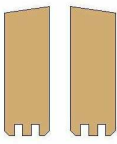
Log profiles	
Profile	Profile

40x57	
40x114	
40x114	
40x58	